

**Research Report
BVAL35-011179**

Customer: TEKES/VÄRE

**MOBILITY OF THE DIESEL ENGINE BASE
OF A RO-RO SHIP**

Paul Klinge

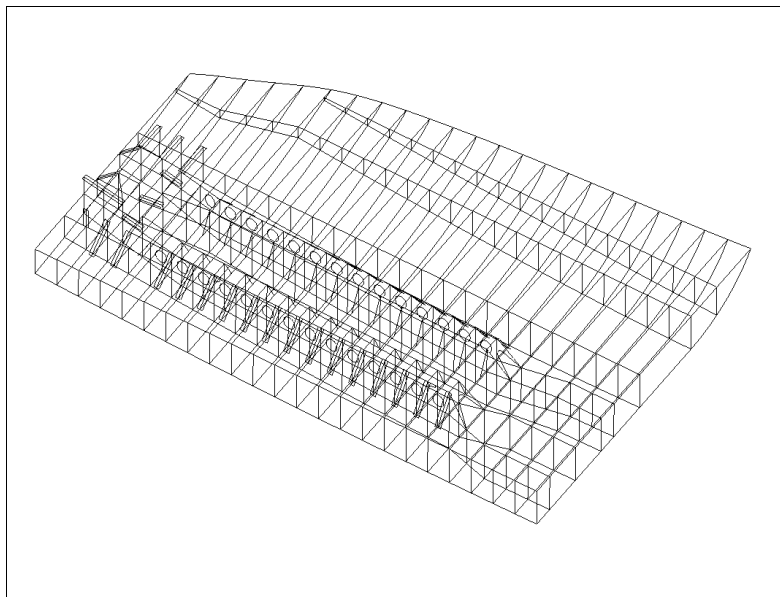

**Espoo, Finland
4 December, 2001**

	A	Work report	
	B	Public research report	X
		Research report, confidential to	
Title Mobility of the diesel engine base of a RO-RO ship			
Customer or financing body and order date/No. TEKES VÄRE technology programme		Research report No. BVAL35-011179	
Project LIKKUTEHO		Project No. V9SU00184	
Author(s) Paul Klinge		No. of pages/appendices 23	
Keywords vibration, mobility, engine base, ship vibration, source strength			
Summary <p>The mobilities of the engine base of a RO-RO ship were calculated with two FE models in frequency ranges 0 - 100 Hz and 100 - 200 Hz. The mobilities of the same engine base with the engines mounted have been measured on the ship and the diesel engine has been measured alone.</p> <p>Also the suitability of FE programs and the traditional calculation method was of interest in this study. In principle the mode superposition method should have worked well and with minimum manual work. However, at every step during the calculation starting from the modelling of the geometry the automatic functions failed due to the large size of the model causing much more manual work than expected. This makes it in practice impossible to use FE programs with the kind of limitations as I-Deas to calculate the mobilities up to required high frequencies.</p> <p>On the other hand the high natural mode density at high frequencies makes the use of the traditional mode superposition method questionable. It can be estimated that in the CPU time, which was used to calculate the natural modes, about 100 direct solutions could have been calculated. Thus for this kind of calculations the feasibility of the direct solution method should be studied.</p>			
Date Espoo 5 December, 2001			
Harri Soininen Research Manager		Paul Klinge Senior Research Scientist Checked	
Distribution (customers and VTT):			
VTT MANUFACTURING TECHNOLOGY Maritime and Mechanical Engineering	Tekniikantie 12, Espoo P.O.Box 1705 FIN-02044 VTT, Finland	Telephone +358 9 4561 Fax +358 9 455 0619, +358 9 456 5888 WWW: http://www.vtt.fi/manu/	

Table of contents

1	Introduction.....	3
2	Goals	3
3	Engine base	3
4	Finite element model.....	4
5	Restrictions of the FE model.....	8
6	Calculation methods	8
7	Results	9
8	Problems	21
8.1	Modelling	21
8.2	Meshing.....	21
8.3	Natural modes	22
8.4	Response calculation	22
8.5	Effect of water.....	22
9	Conclusions.....	23

1 Introduction

This report is part of TEKES supported VÄRE technology programme. One of its research projects LiikkuVÄRE concentrates on vibration and noise control of transport equipment. One of its subprojects concentrates on methods of determining the source intensity of structure-borne noise. The models developed will be applied especially in engine mountings and hull structures.

This paper describes the finite element (FE) model of the engine base of a RO-RO ship and mobility calculation for it. The mobilities of the same engine base with the engines mounted have been measured on the ship and the diesel engine has been measured alone. Later these mobilities will be used to study the diesel engine as a vibration source.

2 Goals

The goal of this study was to determine the mobilities of an engine base for vibration source assessment by numerical calculation. Special interest was on the suitability of traditional commercial FE programs for the calculations.

3 Engine base

A diesel engine can be mounted on the base two ways: resiliently or directly. The resilient mounting is usually constructed with rubber isolators between the engine and the base. The direct mounting means direct bolting of the engine on the base. For this study the direct mounting was selected, because it is much stronger vibration source.

The engine base is a complicated plate structure composed of many plates with openings and brackets (Figure 1). It is also an integral part of the bottom structure in the engine room (Figure 2).

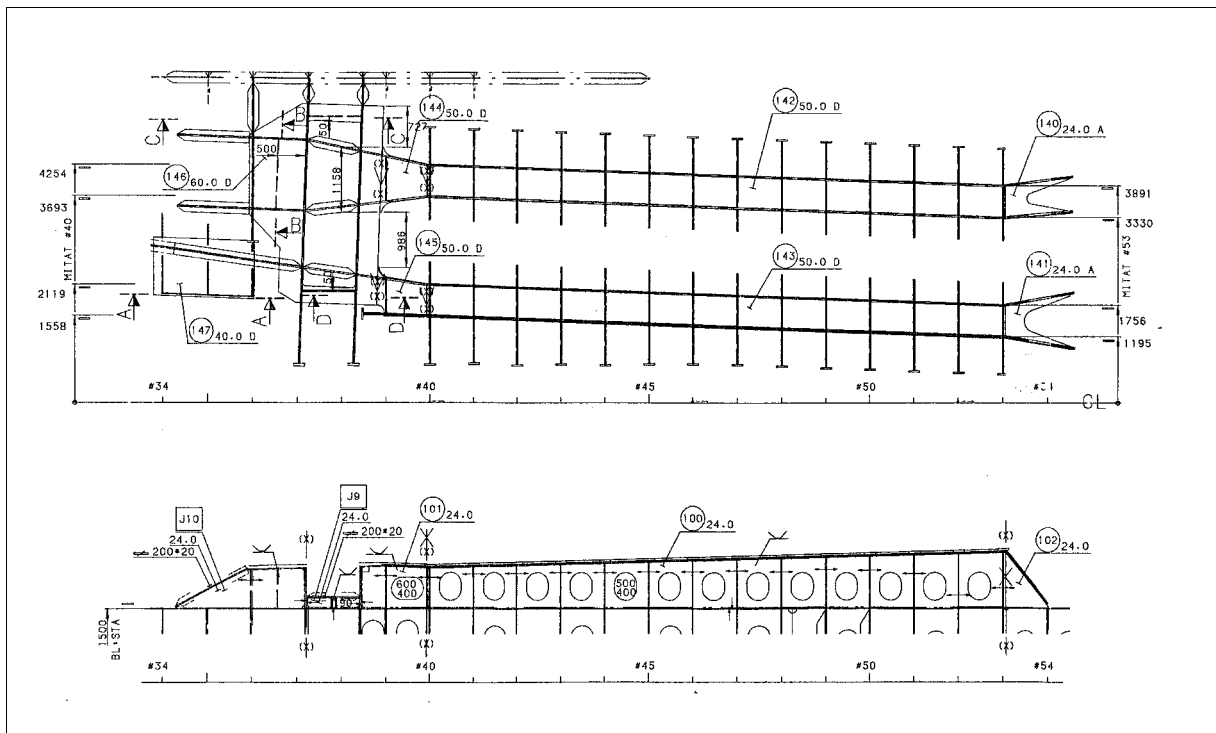

Figure 1. Drawings of the engine base.

4 Finite element model

In this study the aim was to calculate up to 300 Hz the mobilities at points corresponding to the earlier measurements. The size of the elements in the model were chosen to be only 10 cm per side so that the model could describe the behaviour of the structure also at the high end of the frequency range. The small element size makes the FE model large and the calculation times long. To reduce the size of the model a symmetric half-model and an antisymmetric half-model were used.

A half of the engine room was modelled geometrically correctly and the 4-node thin shell elements were generated with I-Deas preprocessor. The FE model contained 100 000 nodes and 105 000 elements. It is shown in Figure 2 and Figure 3.

Later it turned out that the model was too large for practical calculation of the natural modes at higher frequencies. Therefore a smaller FE model was created by cutting the larger model along the girder at 5.8 m from the centre line. The smaller model contained about 67 000 nodes and 72 000 elements. It is shown in Figure 4 and Figure 5.

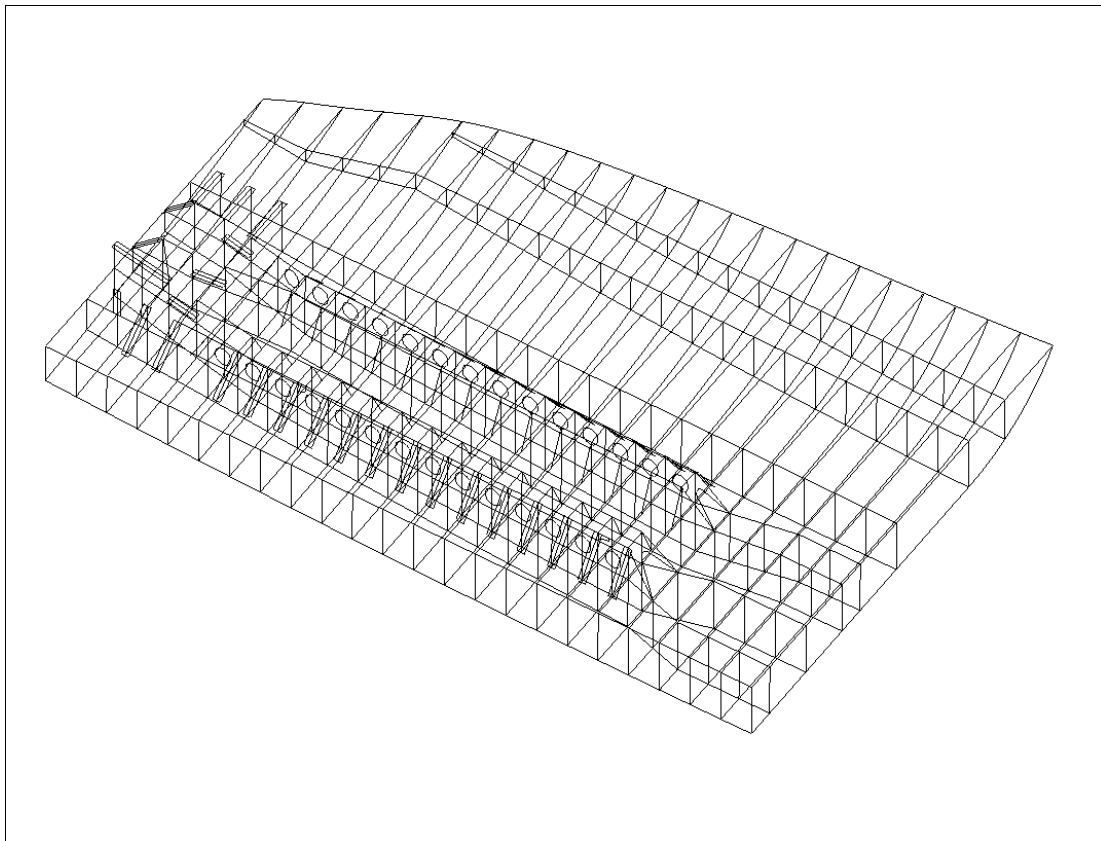

Figure 2. Plates in the half-model of the engine room.

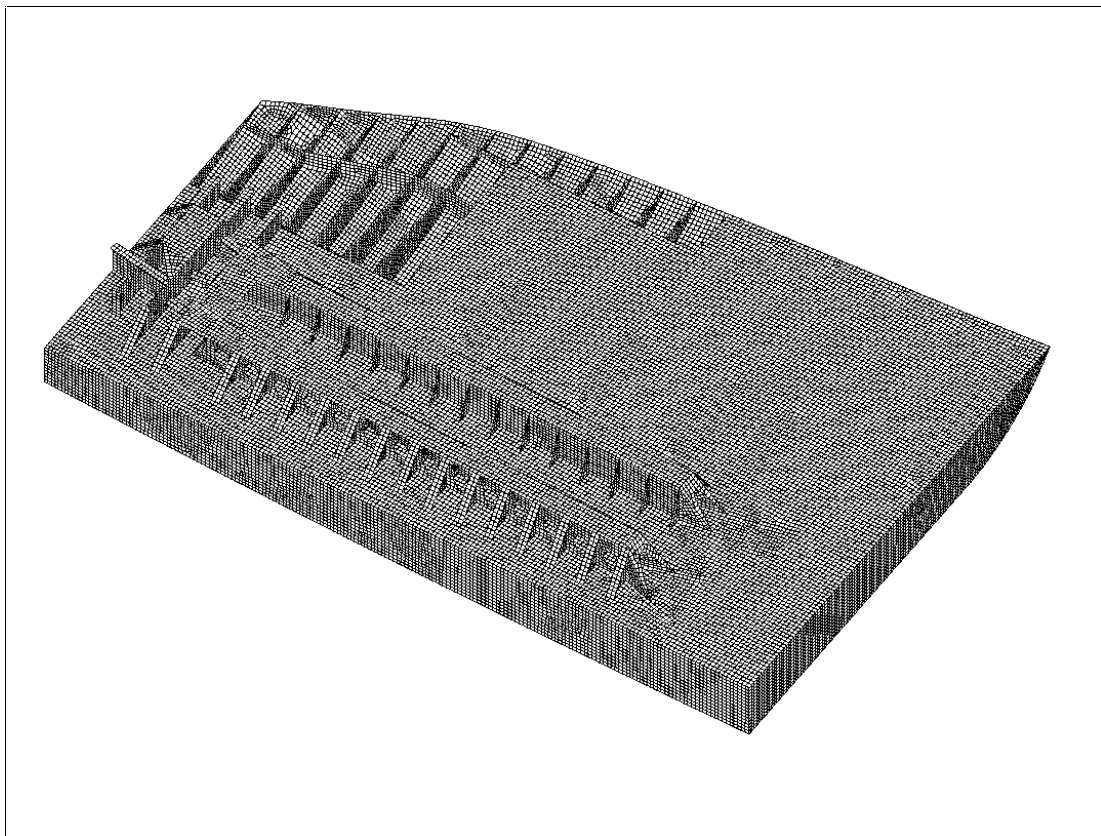

Figure 3. Shell elements of the half-model of the engine room.

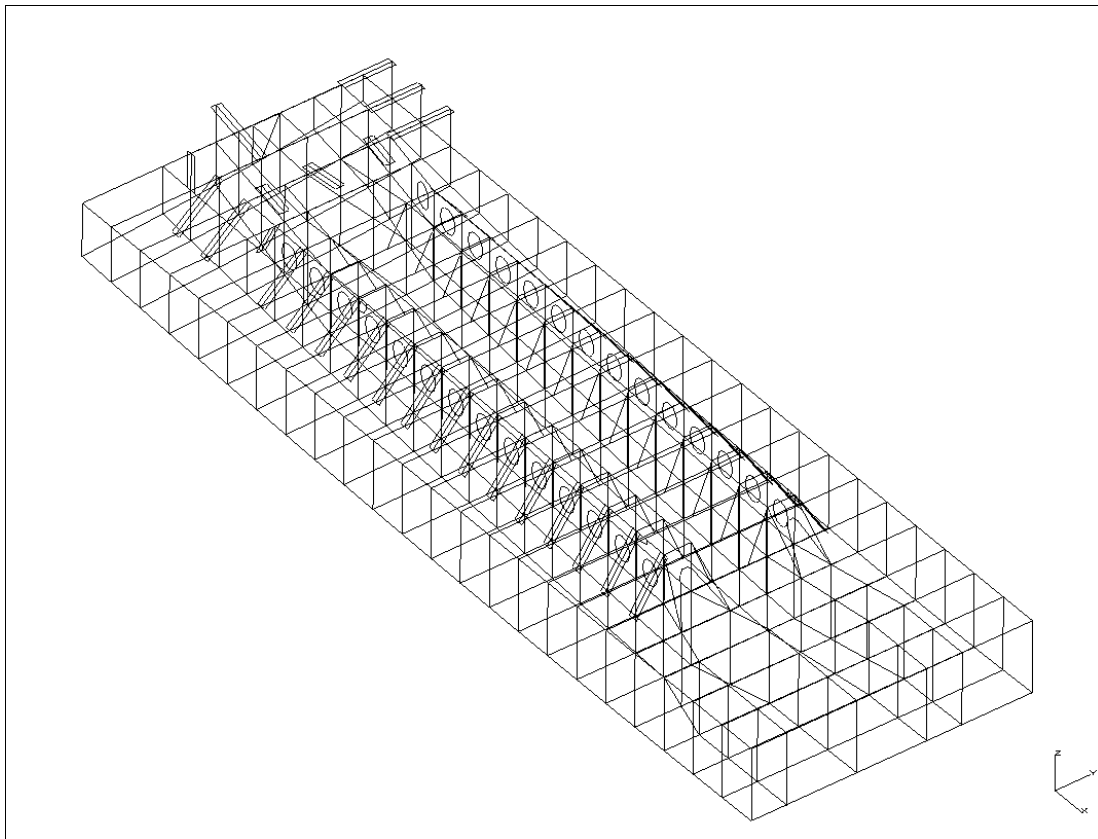

Figure 4. Plates in the reduced model of the engine base.

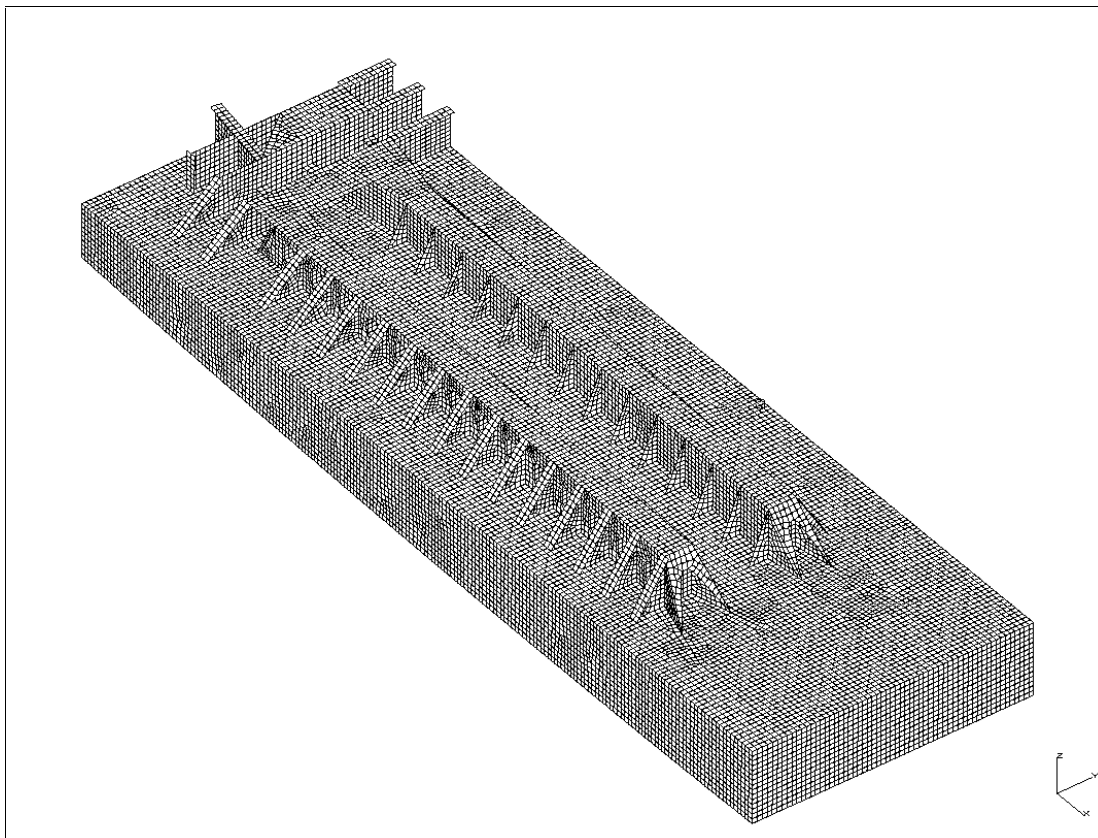

Figure 5. Shell elements of the reduced model of the engine base.

Since the aim is to study the vibration source, the boundary conditions at model boundaries should take into account the energy flow to the major part of the ship that was not included in the model. However, this would have led to frequency dependent boundary conditions with local dampers. Such calculations are practically impossible to carry out with large models. Therefore a simple boundary condition was chosen. All translations were fixed at sections, where the model was cut.

There are problems with this kind of accurate FE model especially at higher frequencies. With ship vibration calculations we are usually not interested in the local behaviour of panels. Then the larger element size or some trick is used to keep local panel modes out, if necessary. If nothing is done, soon after the first natural frequency of a panel, there will be an explosion in the number of natural modes (see Figure 6 and Figure 7). More of the problems in Chapter 8.3.

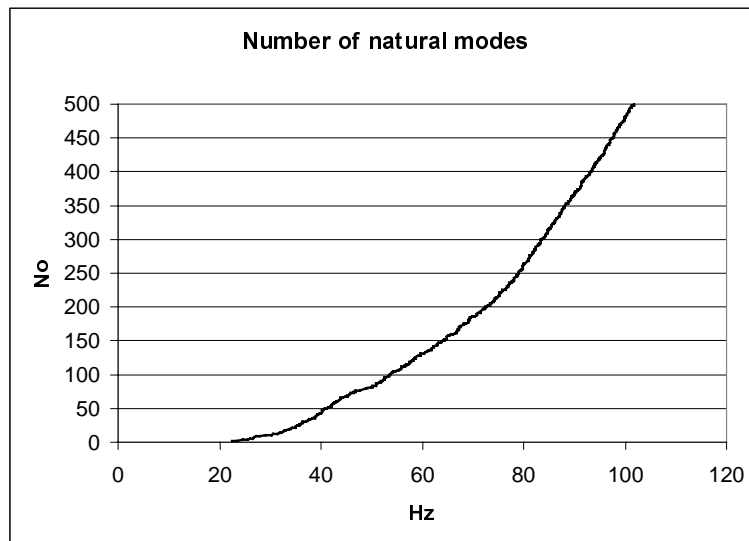

Figure 6. Distribution of natural modes of the large symmetric FE model.

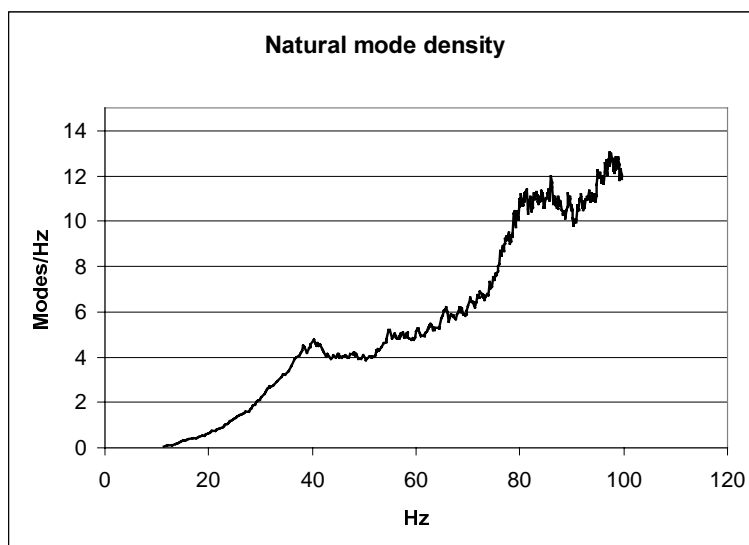

Figure 7. Density distribution of natural modes of the large symmetric FE model.

5 Restrictions of the FE model

The original large model of the whole engine room was considered large enough for the vibration source assessment. The smaller model, which had to be used at higher frequencies, may be too small. The boundary conditions may have some effect on the calculated mobilities.

The boundary conditions at cut boundaries should take into account the energy flow to the part of the ship that is not included in the model. However, this would lead to frequency dependent boundary conditions with local dampers, which in practice impossible with large models. The idea is to take the energy flow to the not modelled structure into account with apparent modal damping factors. They will be later determined by comparing the calculations to the measured mobilities.

Originally the aim was to take the water around the ship into account in the calculations. The vibration energy flows also from the hull to water. However, the Vibroacoustics module of I-Deas did not work with this model. So, the effect of water also has to be taken into account in the apparent modal damping factors.

6 Calculation methods

One goal of this study was to test the suitability of a traditional commercial program for the calculations needed for the vibration source assessment. The SDRC developed I-Deas FE package was used in this study. At the beginning I-Deas Master Series 7 was used and the responses were calculated with version 8m1. A PC NT workstation (Pentium II 400MHz, 256 MB) was used for modelling and calculations.

Traditionally responses of large FE models are calculated with the mode superpositioning method. That is: the natural modes up to about 1.5 times the highest interesting frequency are first determined, the response is calculated in the modal system and this result is transformed back to the original system.

The natural modes of the FE models were calculated with the Lanczos solver of I-Deas. In the Lanczos method a set of orthogonal vectors are first generated and then the natural modes are determined in this vector space. The Lanczos method of I-Deas has been adapted to large natural mode analysis. It automatically selects a frequency range, makes a frequency shift in the middle of the range to accelerate the convergence process. After solving one range a new range is selected etc.

Mobility is velocity/force. Thus by calculating the velocity response with an unit excitation force one gets the mobility. There were 4 excitation points and 8 response points, which corresponded the measurements.

Because the mobilities were calculated for symmetric and antisymmetric half models, they had to be combined to get the mobilities of the whole model. The use of the larger and smaller mode resulted to two sets of mobilities, one from 0 to 100 Hz and the other from 100 to 200 Hz.

7 Results

7.1 Natural modes

Altogether over 2000 natural modes and frequencies were calculated. Some typical natural modes are shown Figures 8, 9, 10 and 11. Only the top 80 % of the amplitude is coloured and areas displaced less than 20 % of the maximum are transparent.

7.2 Mobilities

I-Deas 8m1 was used for the response calculations. The responses were calculated with the mode superpositioning method. Mobility is velocity/force. Thus by calculating the velocity response with an unit excitation force one gets the mobility.

There were 4 excitation points (Figure 12) and 8 response points (Figure 13), which corresponded the ones in the earlier measurement. The nearest node in the model was used for every measurement point, which gives 5 cm accuracy.

The mobilities were calculated for symmetric and antisymmetric half models. The use of the larger and the smaller model resulted two sets of mobilities, one from 0 to 100 Hz and the other from 100 to 200 Hz. Because two copies of every FE model had to be used to cope with the file size limitation, altogether eight response sets (4 excitation and 8 response points each) had to be calculated and combined to get one set of mobilities of the whole model in frequency the ranges of 0-100 Hz and 100-200 Hz.

Damping ratio 0.5 % was used in the calculations. The calculated mobilities are presented on pages 13 - 20. The first two letter in the title show the excited engine base (BB = portside, SB = starboard) and the last two letters and two numbers give the excitation point. The correspondence with the points, where mobilities were measured, and the nodes in the FE models is shown in Table 1.

Table 1. The correspondence with the mobility measurement points and nodes in the FE models.

Measurement point	Calculation node
SB1	4725
SB2	4515
SB3	4189
SB4	3997
BB5	6010
BB6	1077
BB7	651
BB8	451

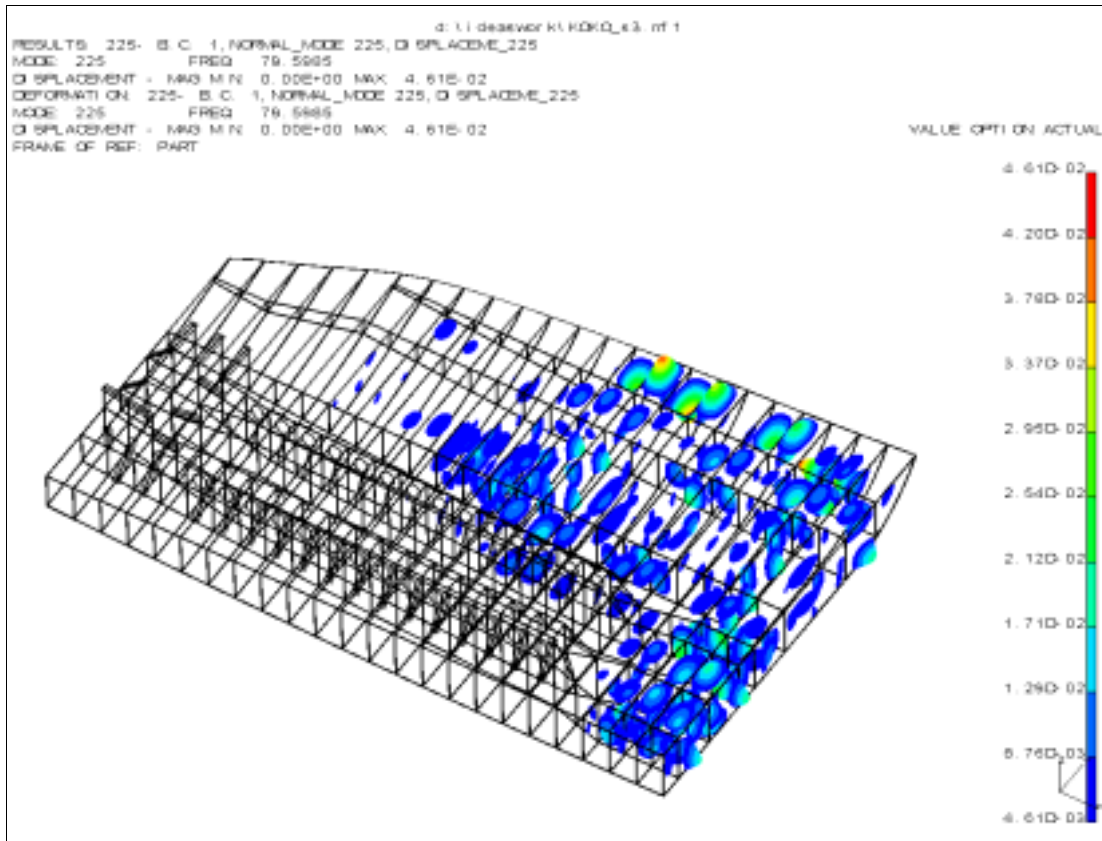

Figure 8. Natural mode at 79.6 Hz.

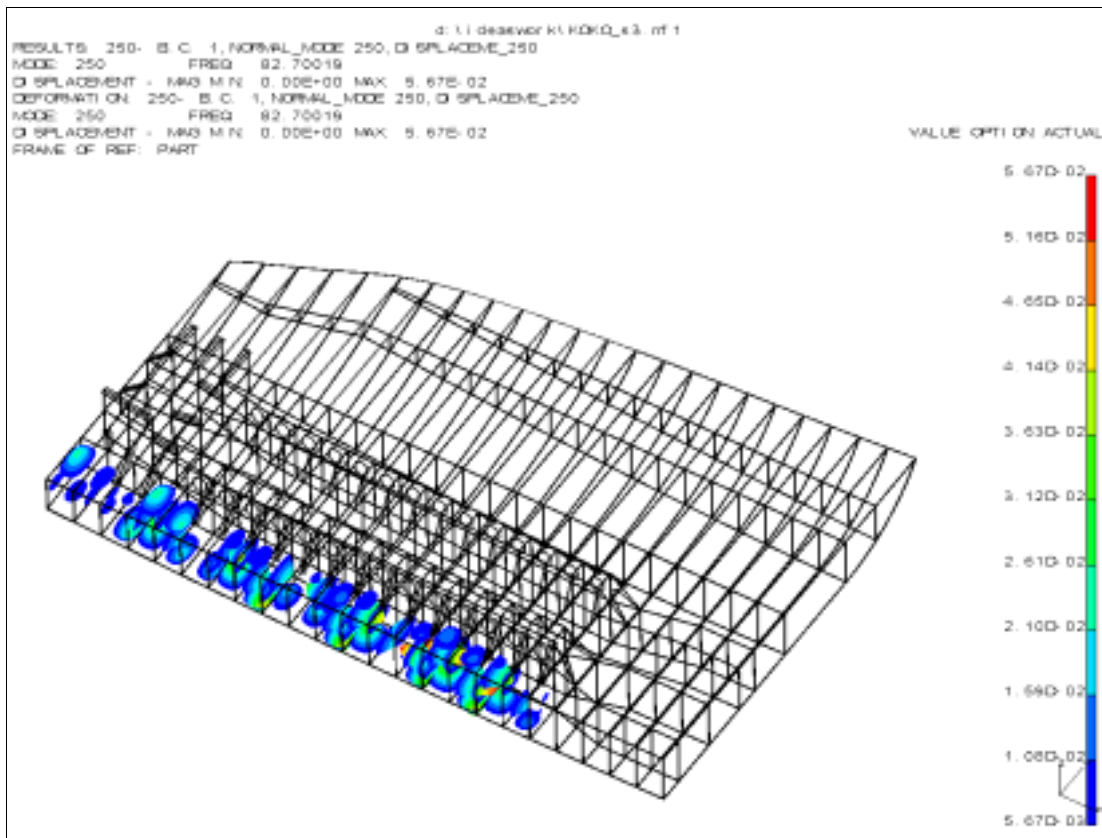

Figure 9. Natural mode at 82.7 Hz.

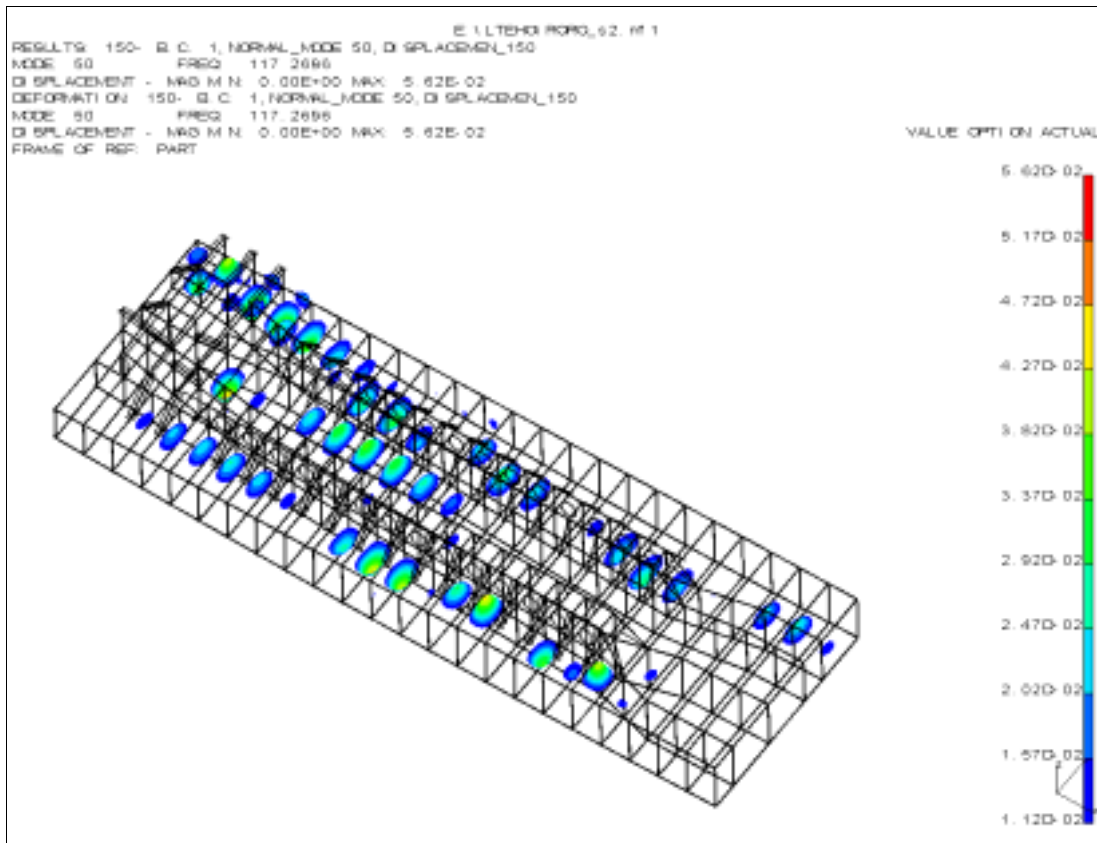

Figure 10. Natural mode at 117.3 Hz.

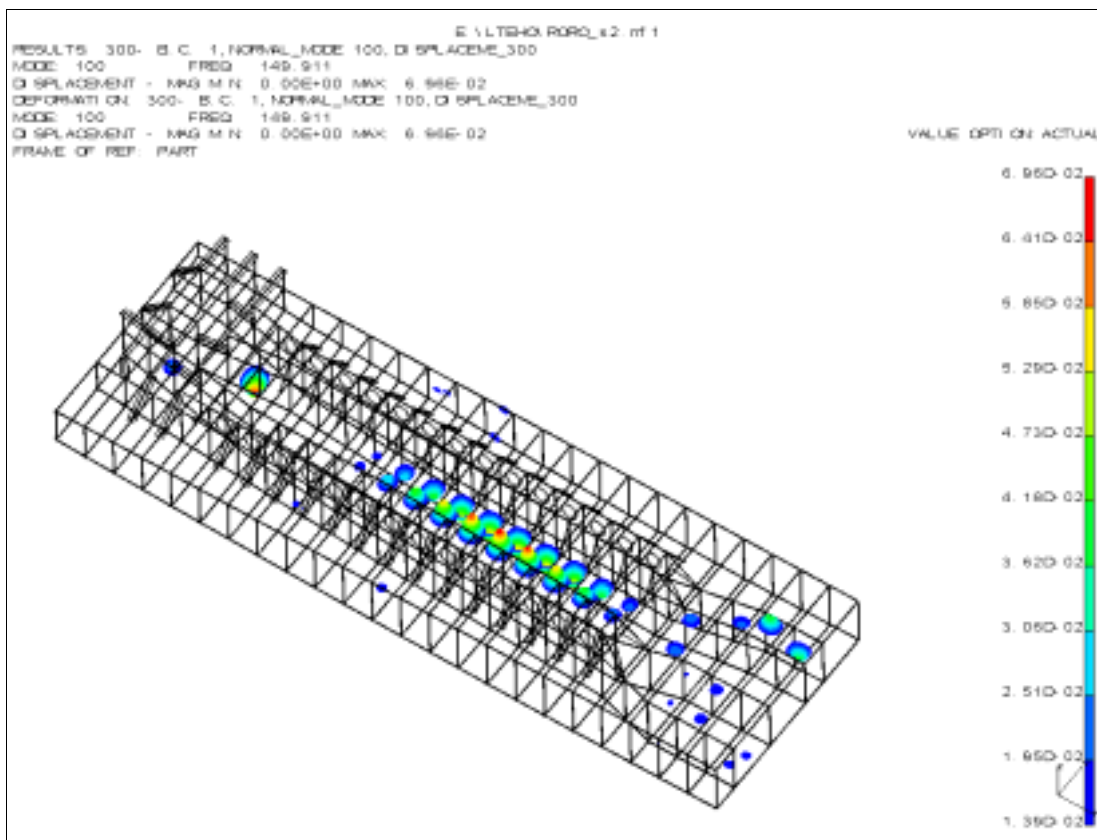

Figure 11. Natural mode at 149.9 Hz.

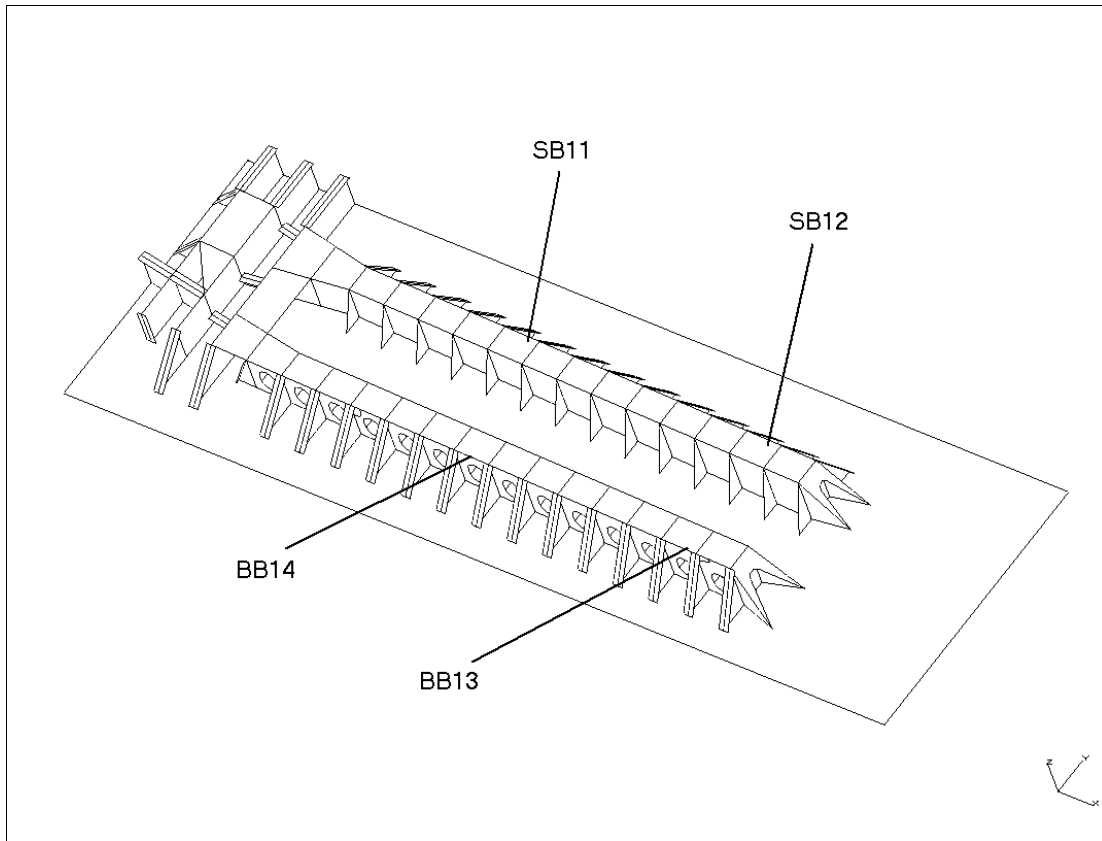

Figure 12. The excitation points.

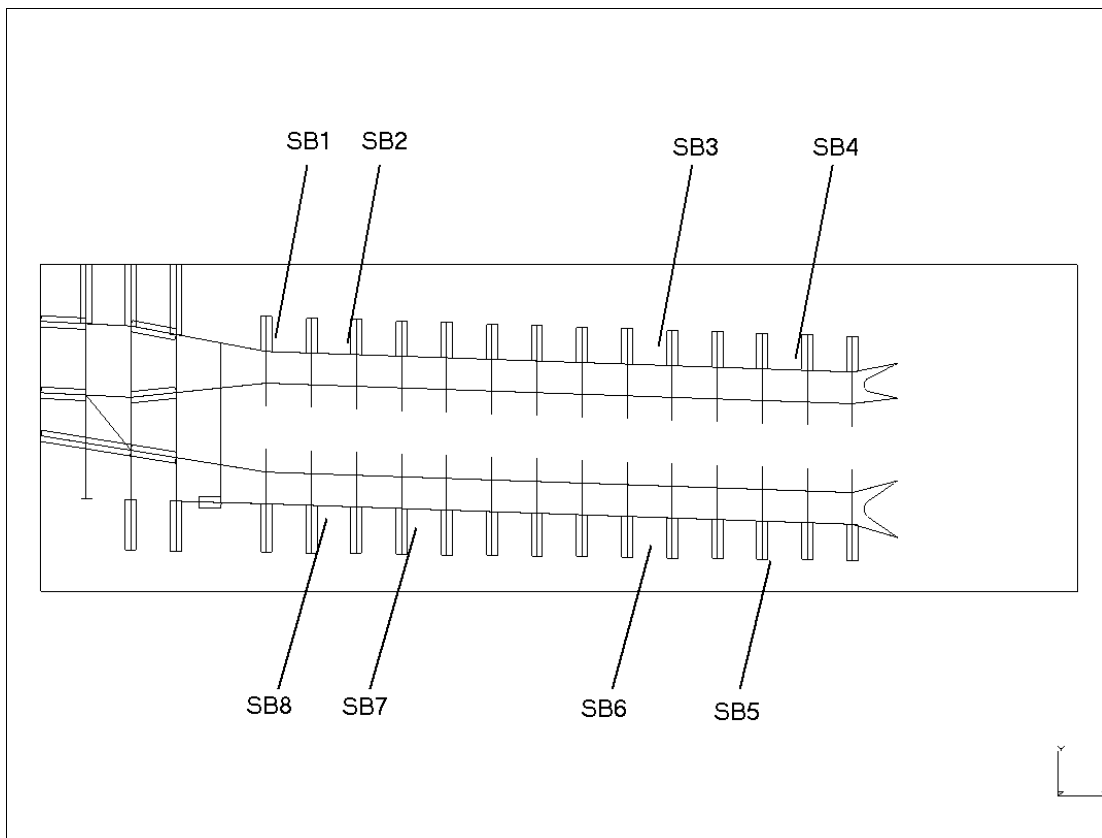
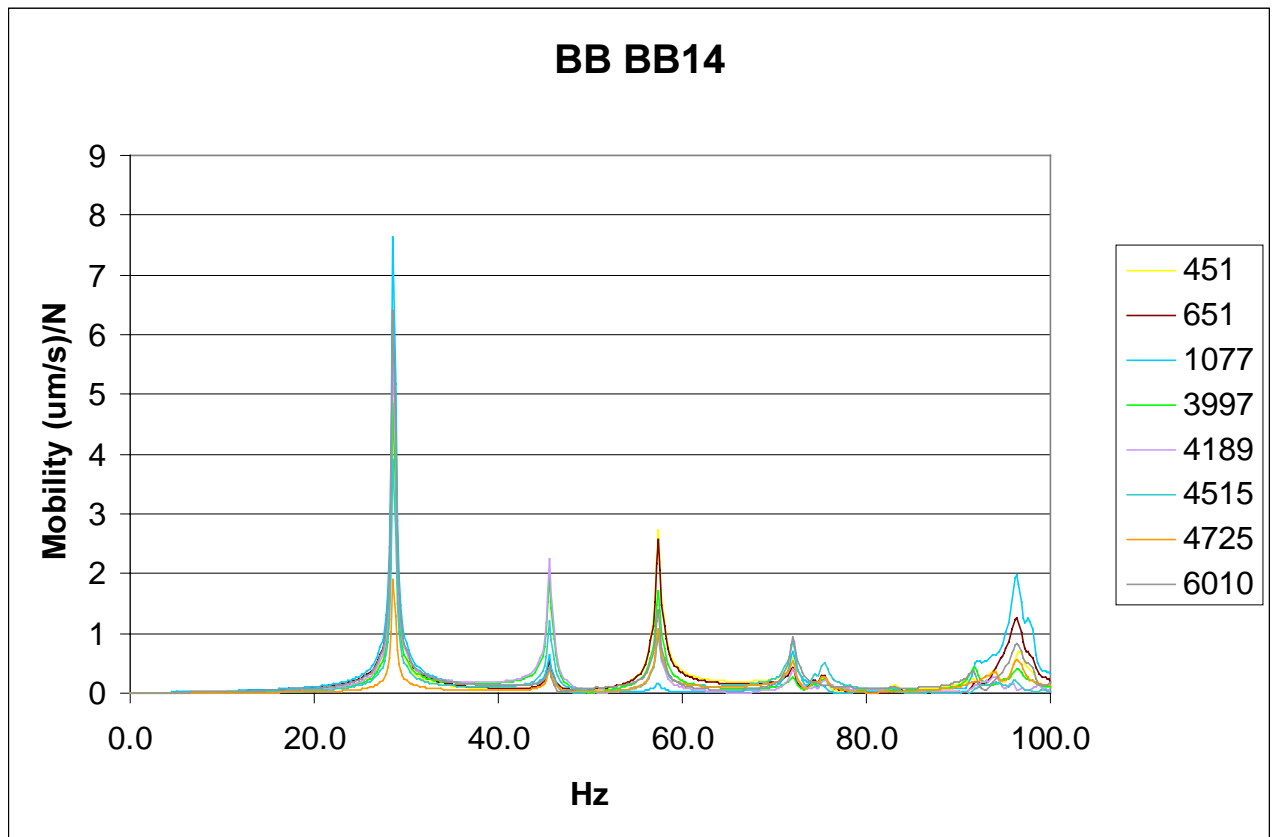
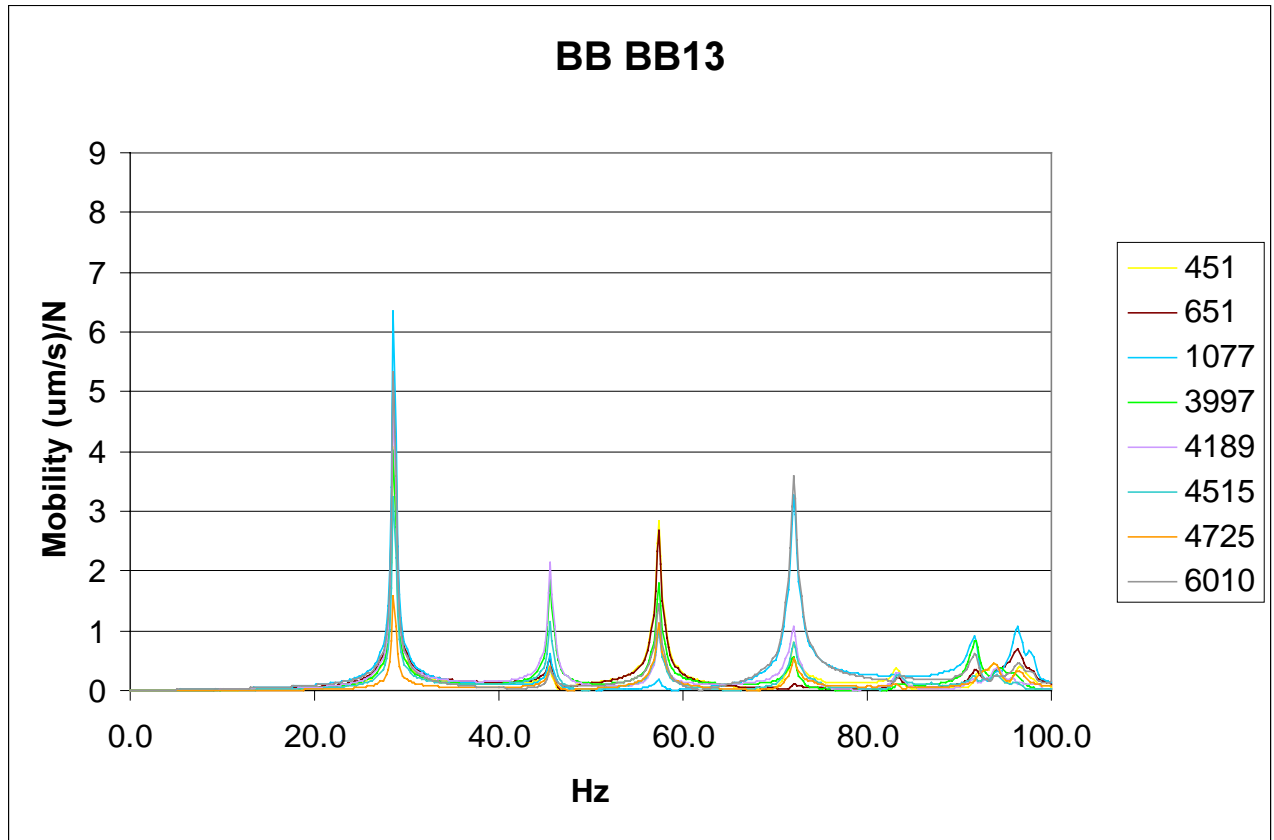
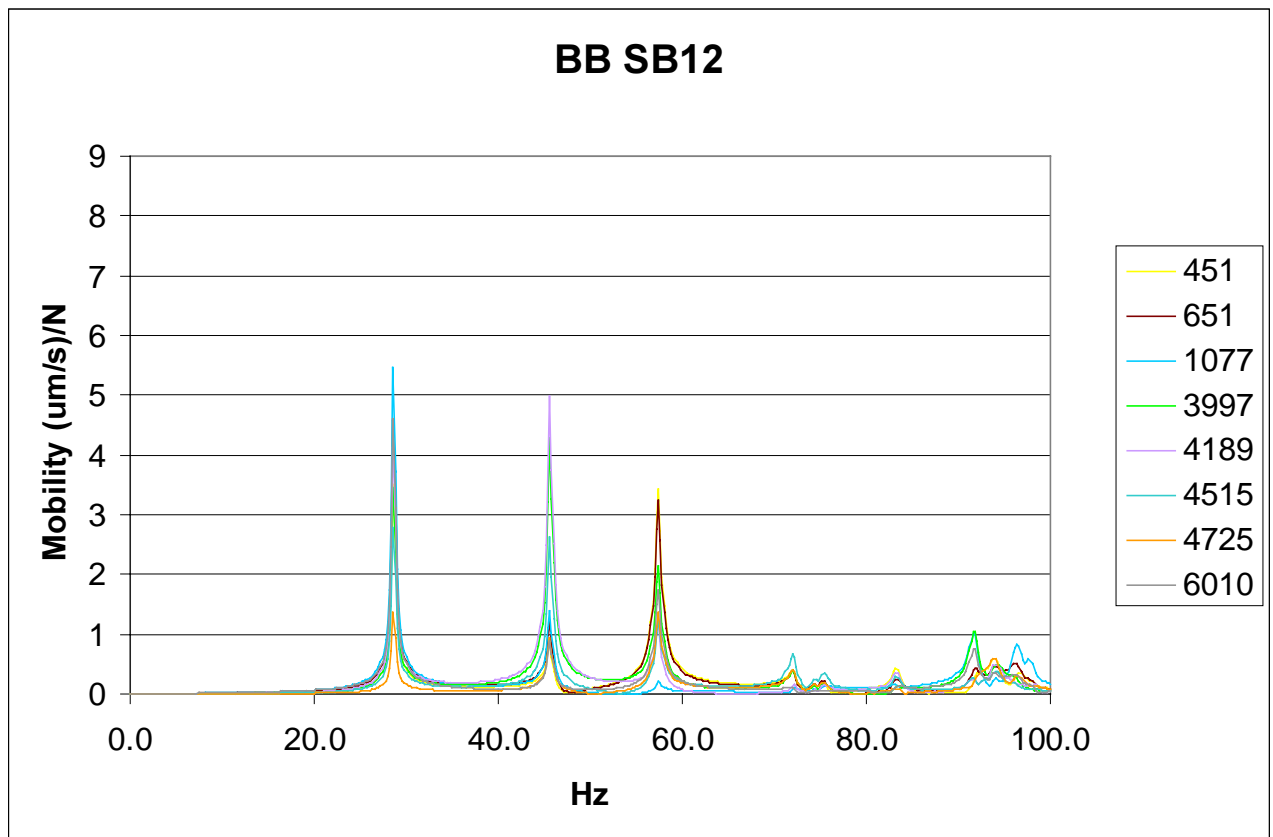
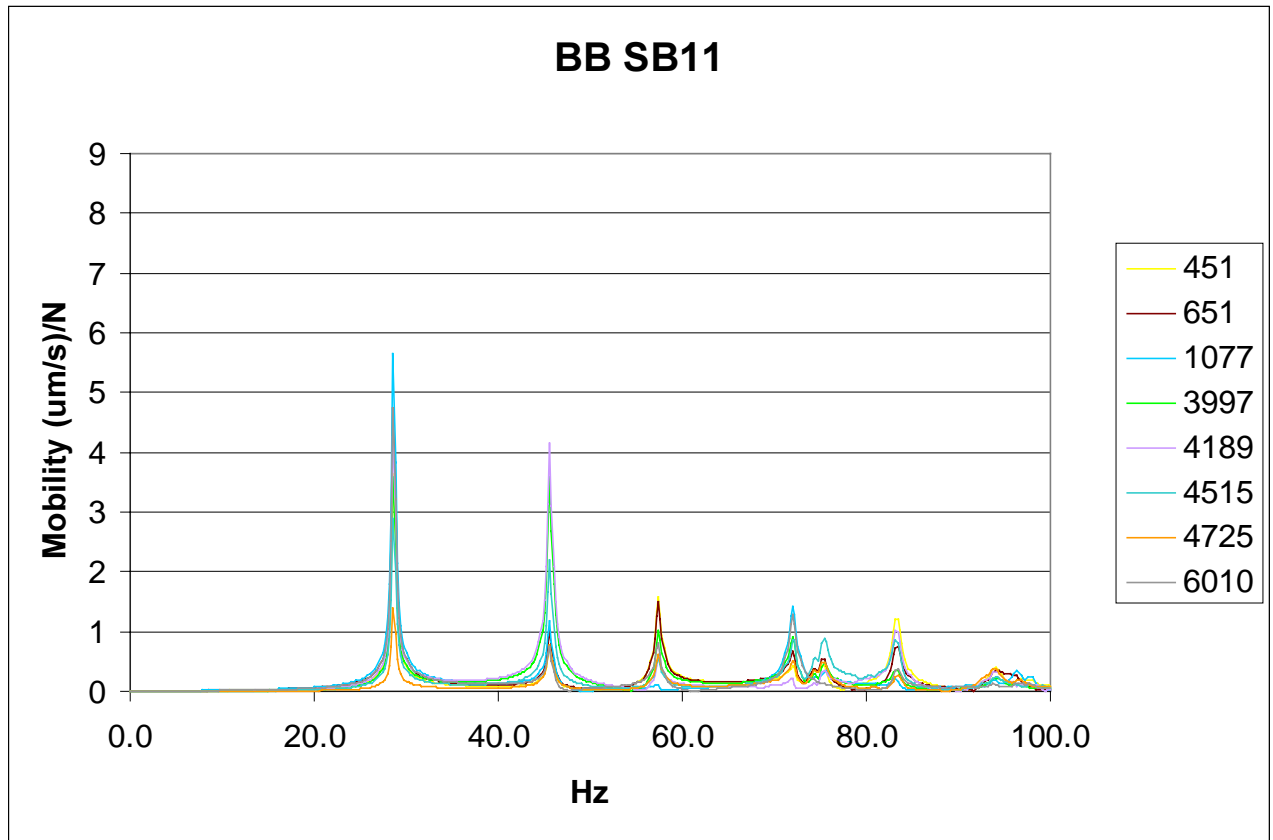
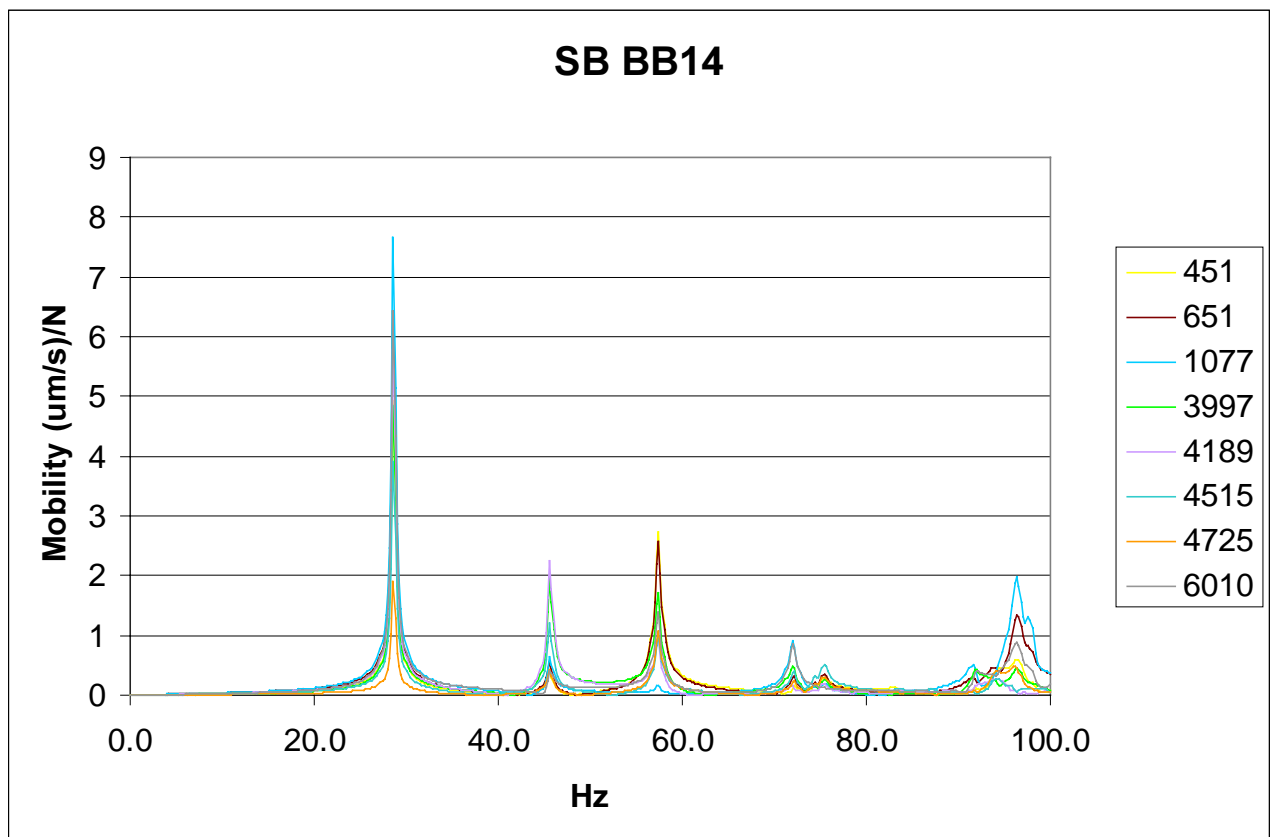
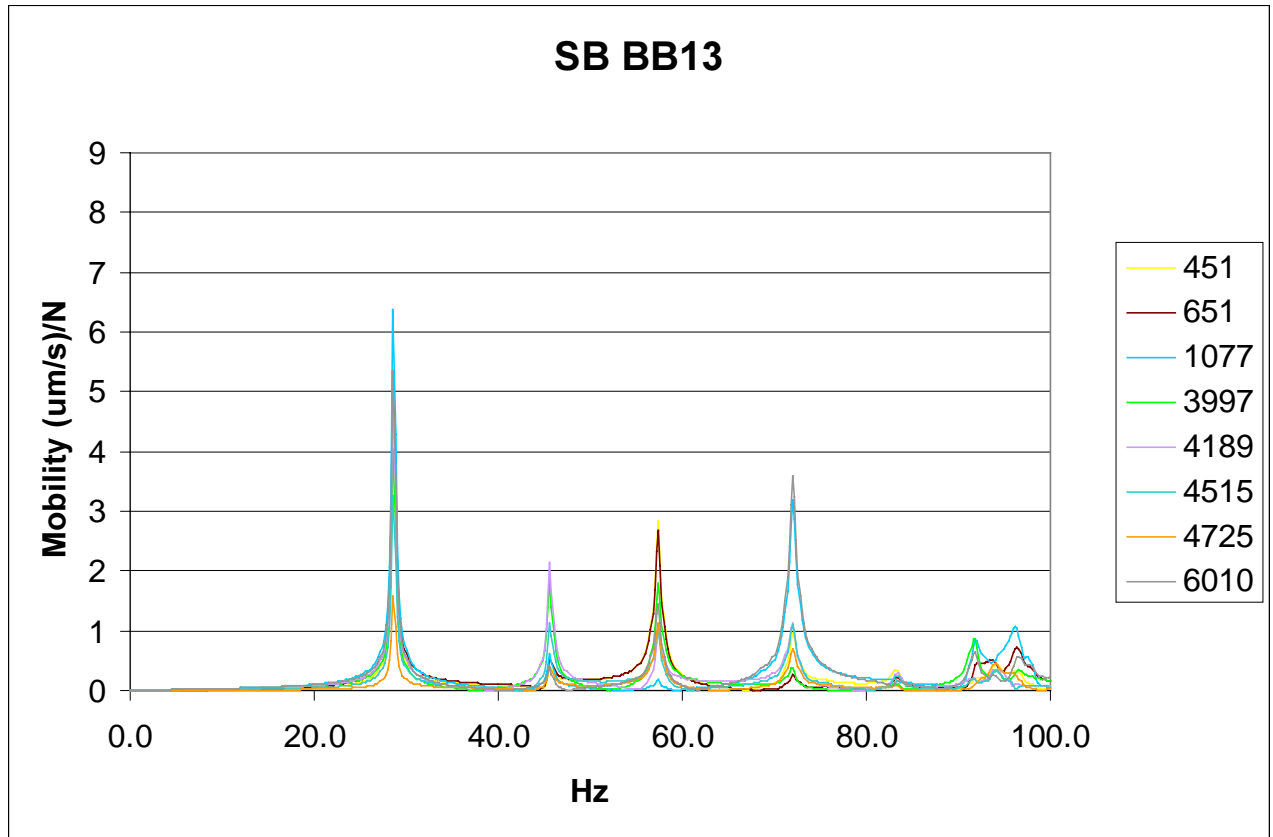
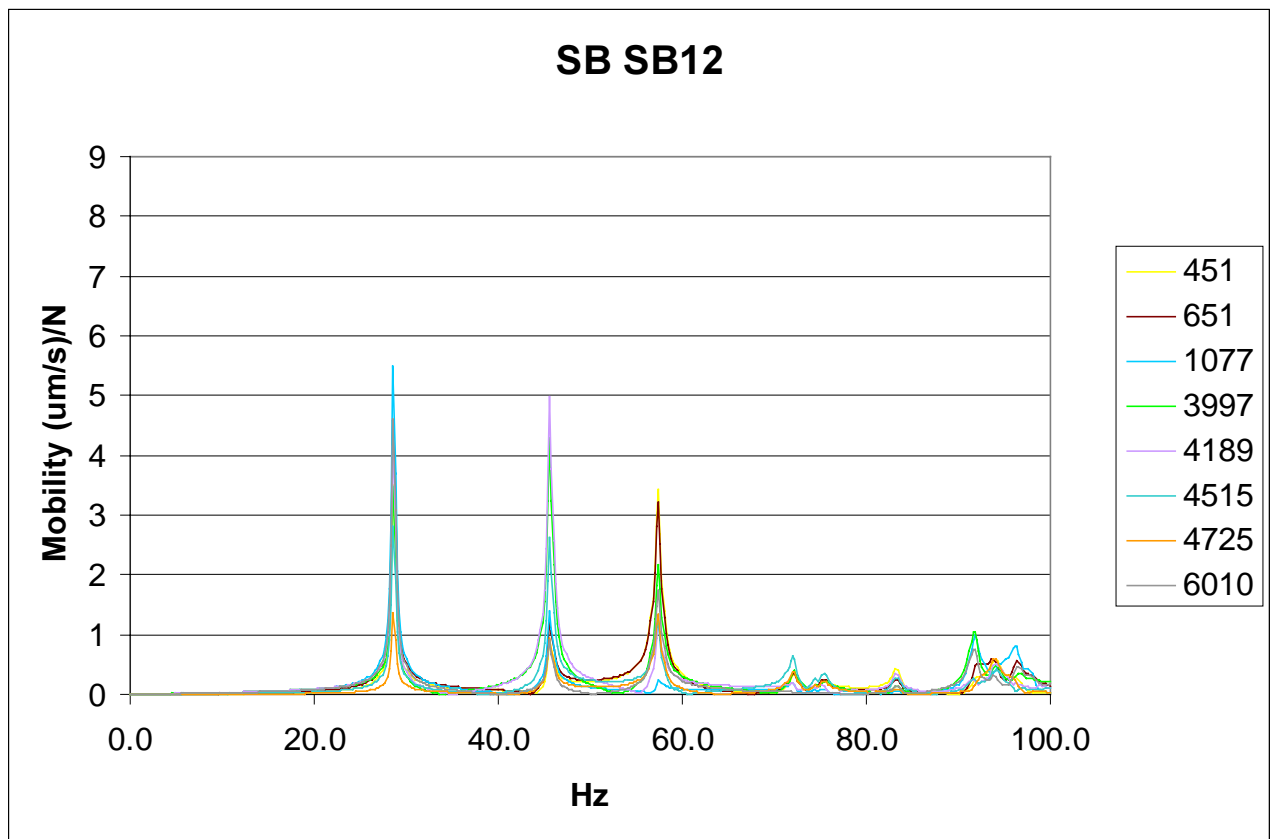
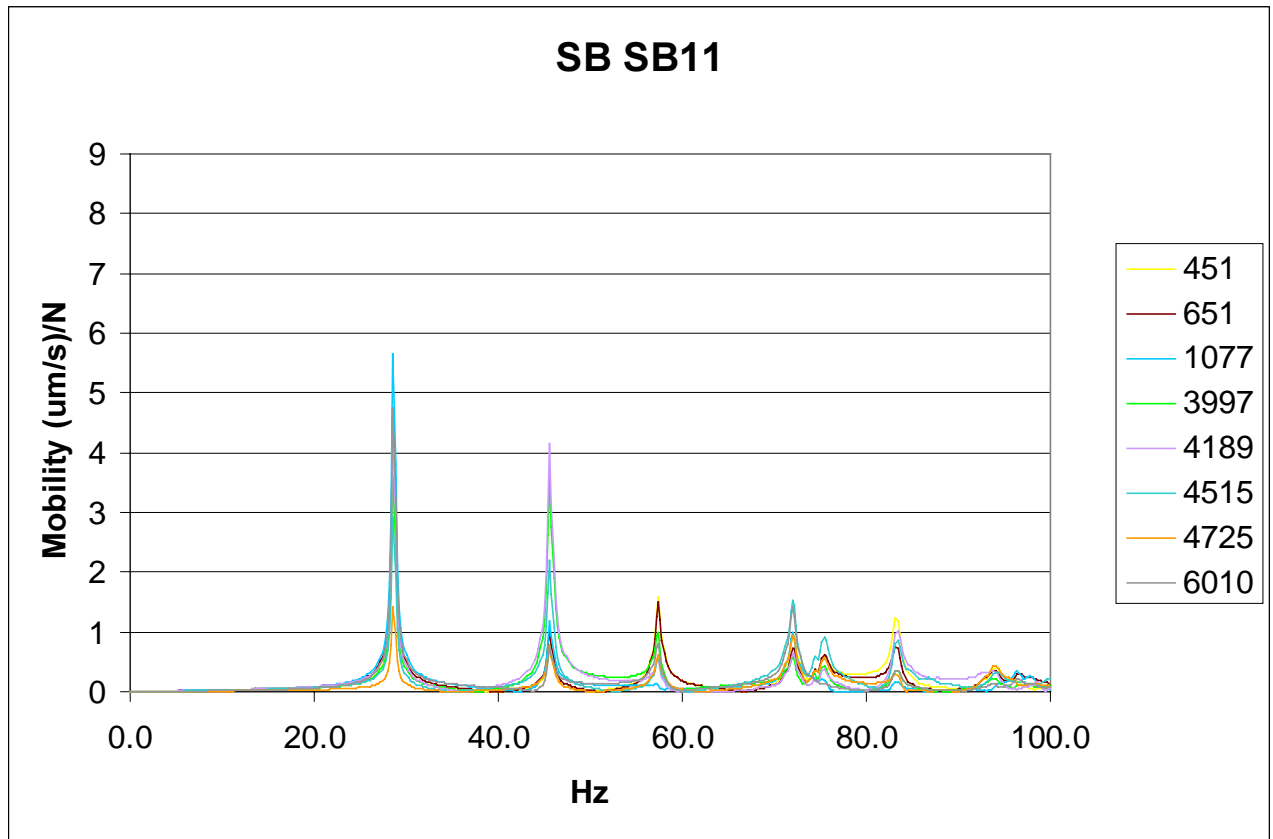

Figure 13. The response points.









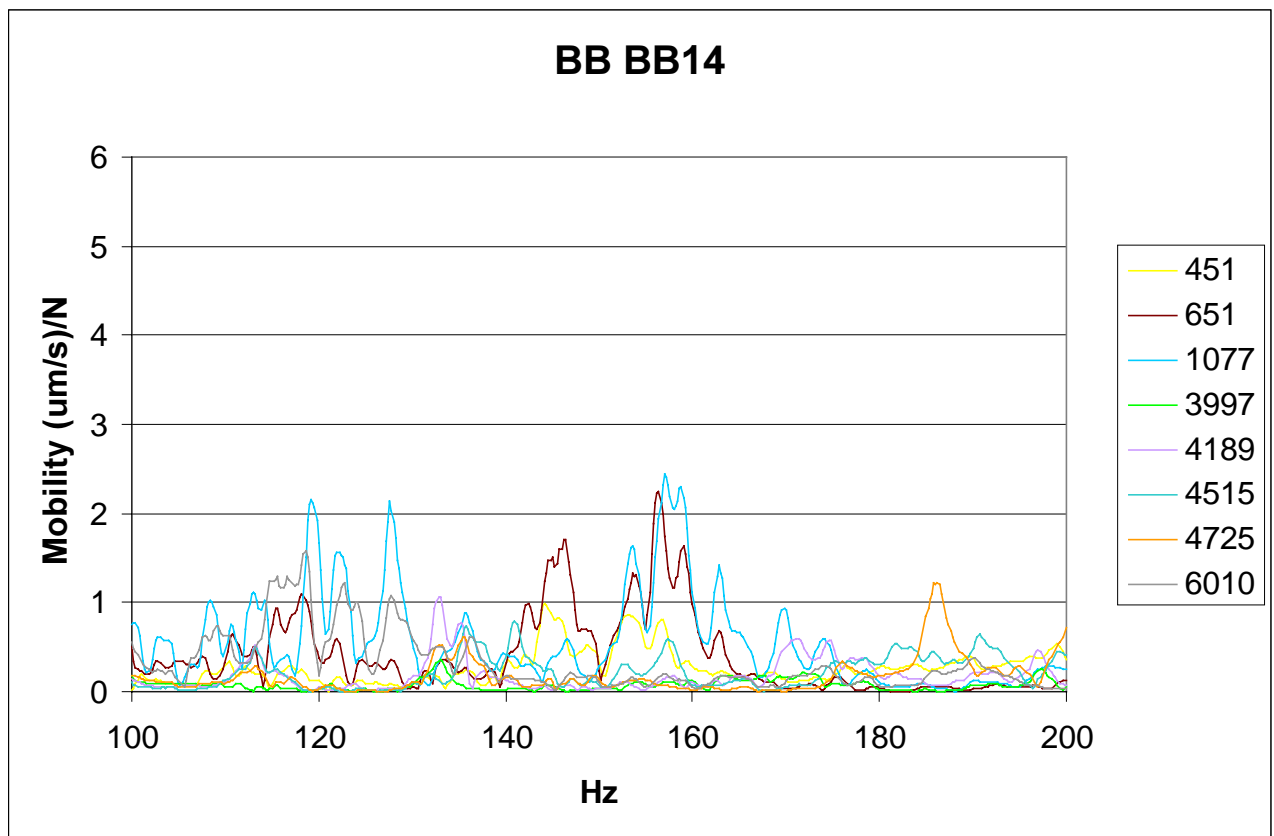
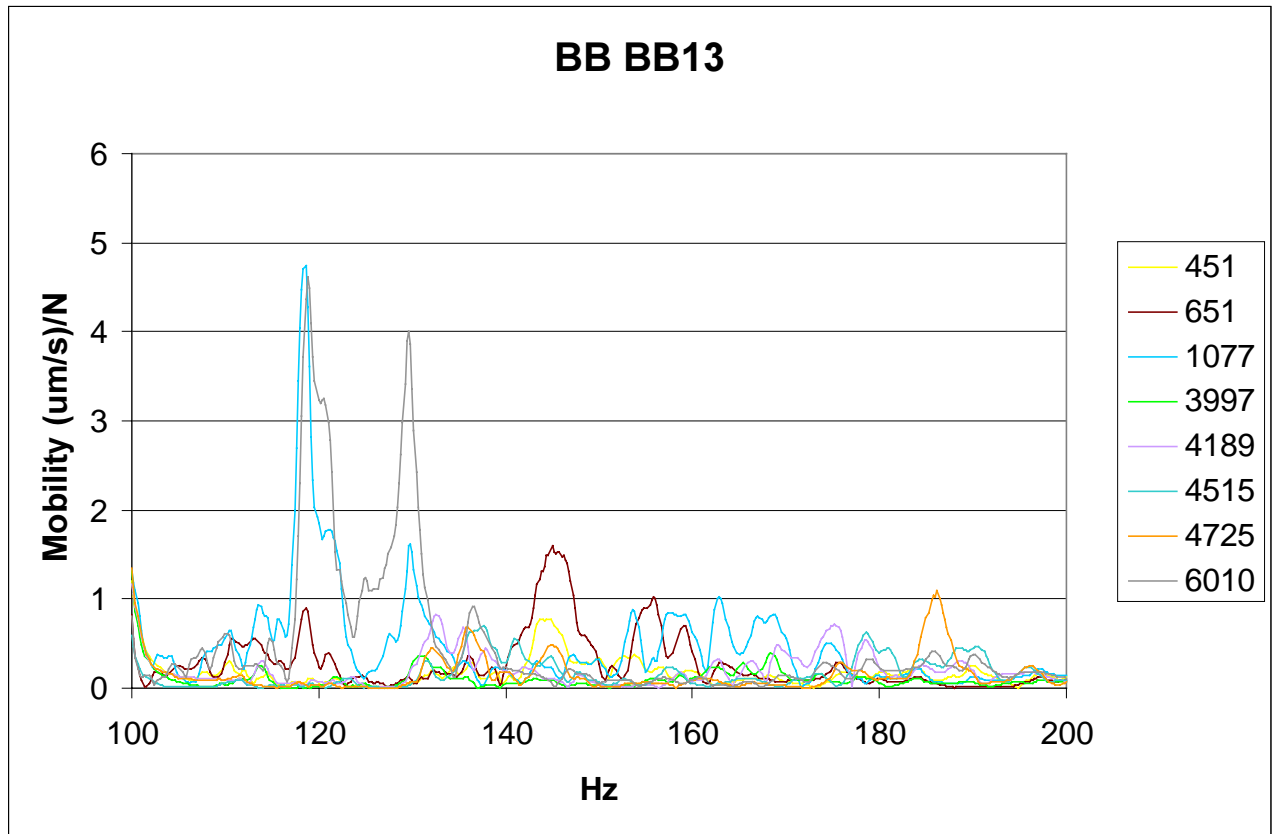

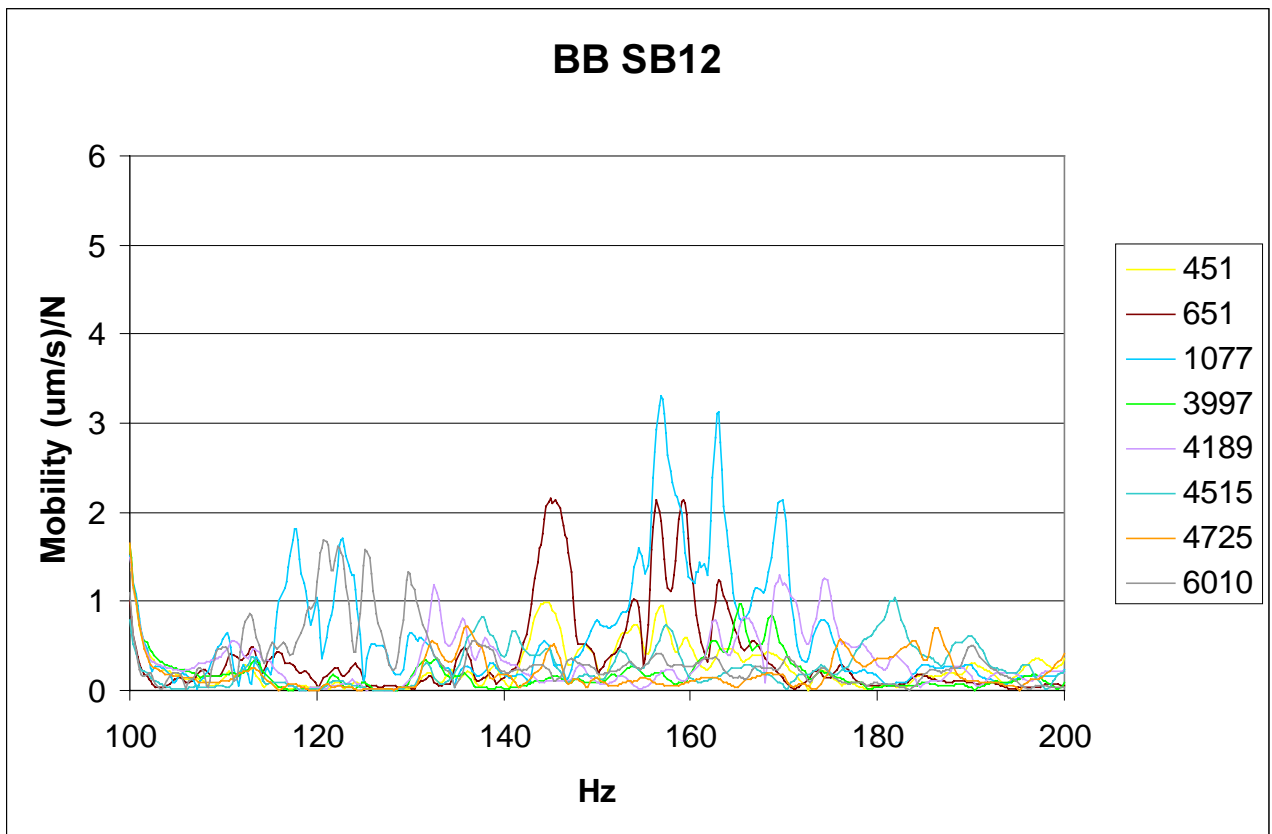
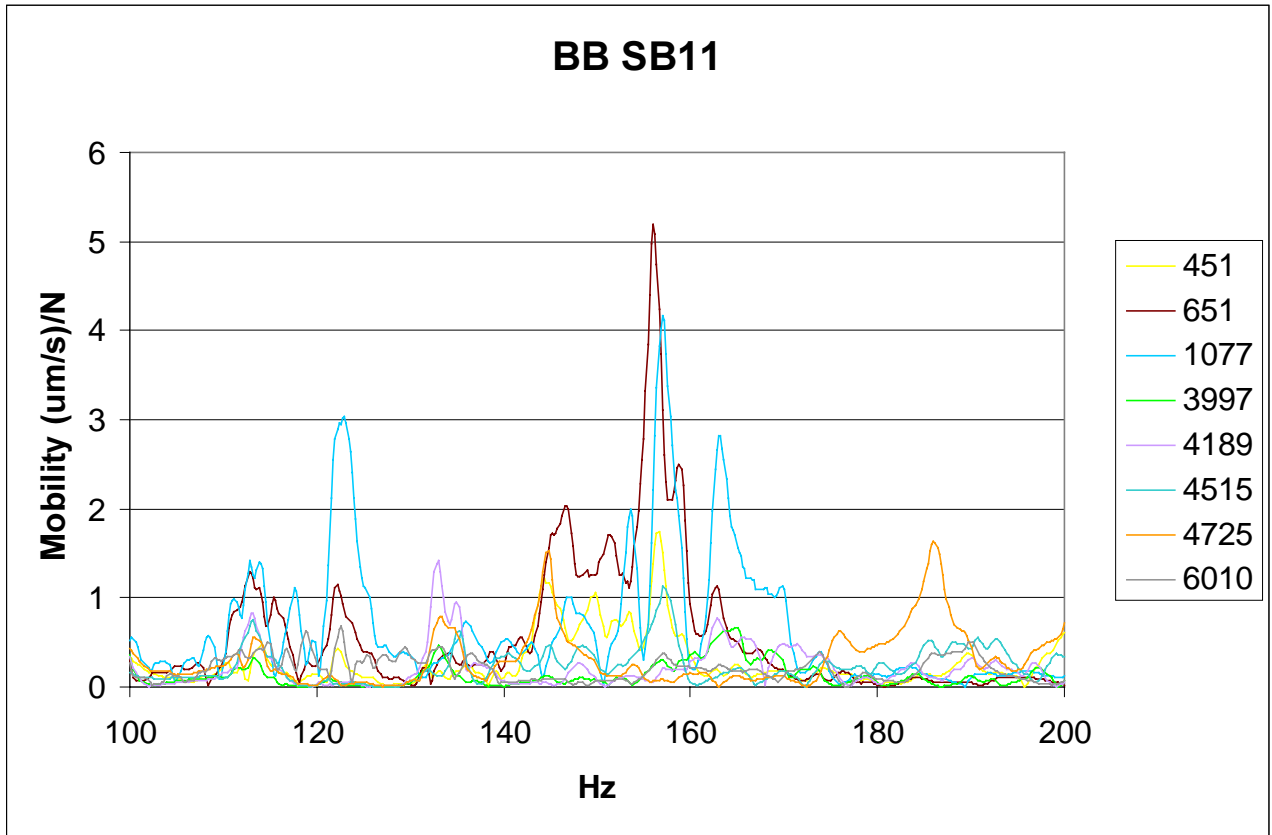

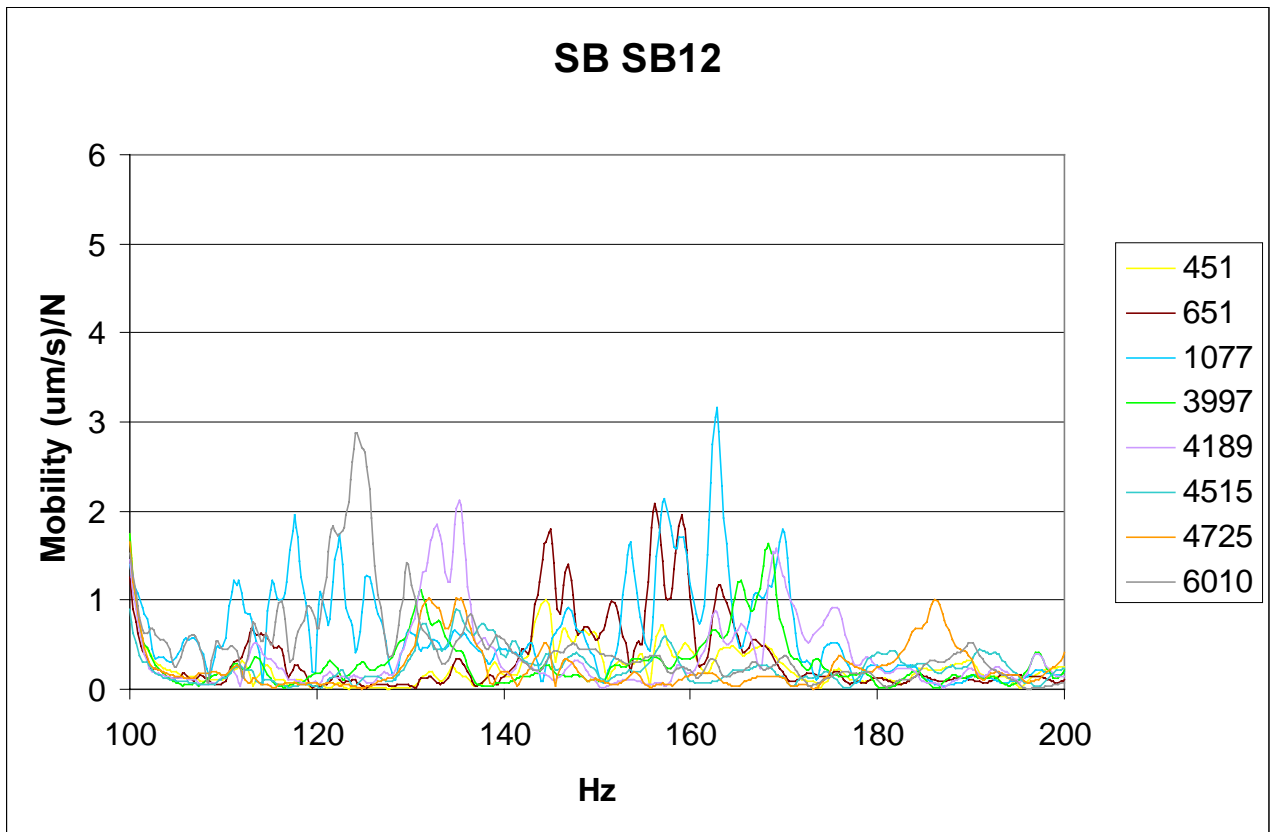
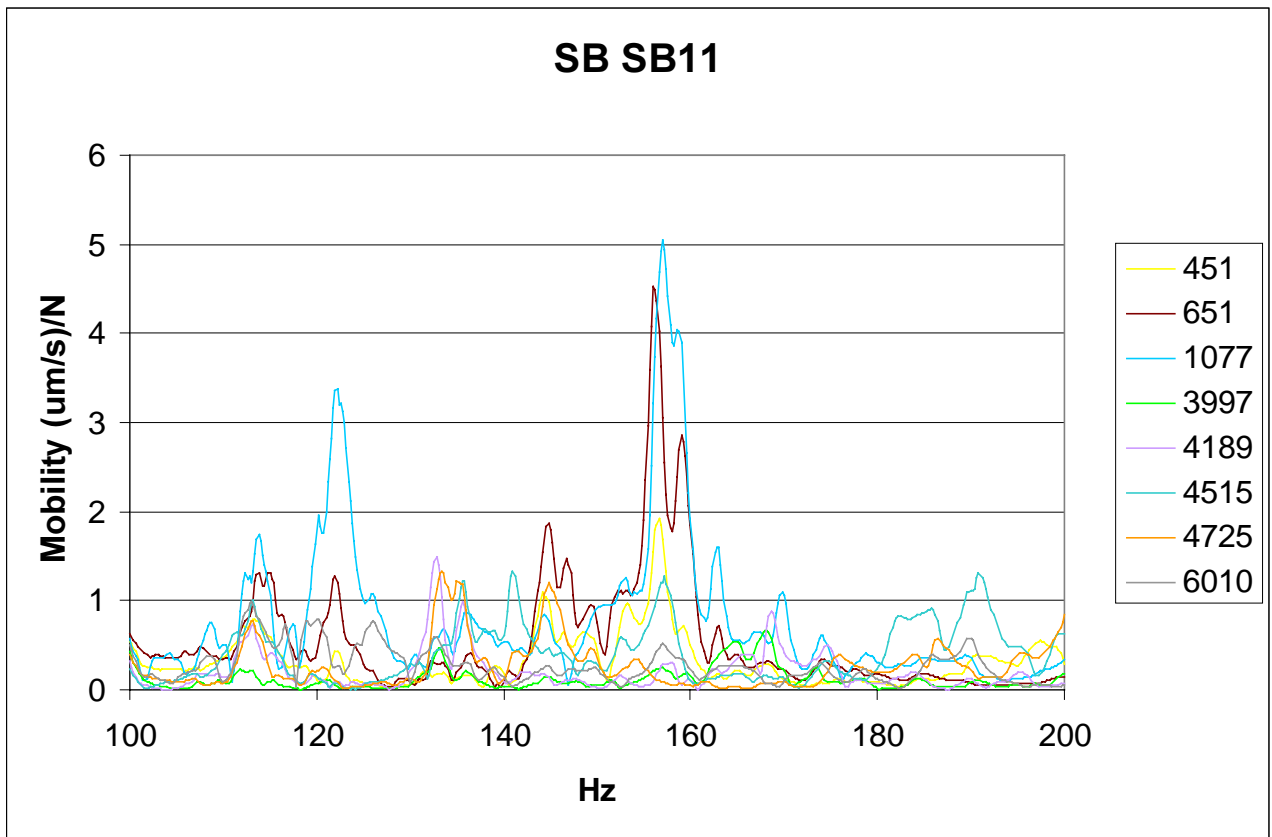

8 Problems

One goal of this study was to test the suitability of a traditional commercial program for the calculations needed for the vibration source assessment. In this study I-Deas FE package was used. Mainly version 7 was used, but the responses were calculated with version 8m1. A PC NT workstation with Pentium II 400MHz processor and 256 MB memory was used for modelling and calculations.

8.1 Modelling

The FE mesh creation with I-Deas is based on the geometry model. The double bottom of a ship is fairly complicated box structure, but in principle it is easy to model. First the bottom and tank top are modelled and then transverse frames and longitudinal girders are added by partitioning the geometry model. However, it soon turned out that I-Deas was not able to perform correctly multiple simultaneous partitionings as the number of surfaces in the geometry model grew. At first it helped to make only one partitioning at a time, but soon it too failed. Finally only one surface could be partitioned at a time.

The partitioning took increasingly more time as the number of surfaces grew. Finally there were over thousand surfaces in the geometry model and it took almost 5 minutes to perform one partitioning. The most of the time was used to prepare the default surface list for the dialog window, which was quite unnecessary, since only one surface could be partitioned at a time! However, it was impossible to change the default behaviour.

These problems caused many times more manual work and took many times more time per operation than anticipated. Altogether it took many tens of times longer to make the geometry model than was anticipated. Of course, also other approaches to the modelling were considered and tested, but either the modeller program failed completely or similar problems were encountered.

8.2 Meshing

The large number of surfaces caused problems also with meshing. However, they were easily solved by meshing the different structural parts in several sets.

More work demanded problems with the automatic meshing algorithm, which refused to mesh many surfaces. This is due to incompatible numbers of nodes on the edges of the surface, which in turn was due the curved bottom of the ship. The solution was to model the problematic surfaces and the bottom surfaces in connection with them manually.

Another problem with the automatic meshing was very small, practically invisible, cuts on the surfaces. They were found mainly in and around the engine base, probably because it is slightly off from the rectilinear direction. These cuts caused the meshing algorithm to generate very small elements around them. The best way to overcome this difficulty turned out to be manual manipulation of the generated FE mesh. This was done by deleting the small elements and replacing them with 4-5 larger elements by hand.

8.3 Natural modes

There were a lot of problems with the calculation of the natural modes. I-Deas was updated to version 8 (and soon to 8m1) at this stage of the project. For one reason or another this version of the program was only able to calculate only a few lowest natural modes, but the solution of any larger number never finished. When it was verified that the reason is the version of I-Deas and not computer settings, lack of memory, etc. the calculation was reverted back to using version 7. Only problems regarding I-Deas version 7 are reported here.

The Lanczos method was used for the natural mode calculation, because it has been adapted to large natural mode analyses for I-Deas. The user can ask the program to find all natural modes and frequencies in a given frequency range. Then, in principle, only CPU time and disk space is needed. However, the calculation ran into new problems.

One of the problems was expected, because of the large frequency range (0-300 Hz) of the calculation. The first natural frequency of local panels (plates between frames and girders) was at about 70 Hz. Thus a considerable increase in the mode density after 70 Hz was expected (Figure 7). The answer to this problem was reducing the extent of the FE model and thus reducing the number of panels. It was decided to calculate the natural modes in the range 0-100 Hz with the original FE model and the higher modes with the reduced FE model.

There were also problems with disk space and file sizes. A very large number of natural modes were found in the studied frequency ranges, about 500 natural modes each. So, the run time requirement for the disk space with the larger FE mode grew up to 6 GB. A new hard disk had to be acquired to be able to go through the calculations. It was not, however, possible to calculate all the natural modes in a range with one FE model. The maximum size of a file in a PC is about 2 GB. If any of the run time files or the model file grew larger than 2 GB the calculation halted. Two copies of every FE model had to be used to cope with the file size limitation. Altogether eight FE models were needed for the calculation of the 2500 natural modes in the frequency range 0-200 Hz. It was practically impossible to go on up to the 300 Hz, which was the original goal.

8.4 Response calculation

I-Deas 8m1 was used for the response calculations. The responses are calculated with the mode superpositioning method with I-Deas. No actual problems were encountered, but eight response sets (4 excitation and 8 response points each) had to be calculated and combined to get one set of mobilities in frequency the ranges of 0-100 Hz and 100-200 Hz.

8.5 Effect of water

Originally the aim was to take the water around the ship into account in the calculations. I-Deas includes also the Vibroacoustics module. It can calculate the response of a structure in fluid by using the natural modes of the structure and boundary element method (BEM). However, the Vibroacoustics module could not read the FE model in. This was probably due to the large size of the FE model or to the huge number of the natural modes, since small example models worked.

9 Conclusions

The mobilities of the engine base of a RO-RO ship were calculated with two FE models in frequency ranges 0 - 100 Hz and 100 - 200 Hz. The mobilities of the same engine base with the engines mounted have been measured on the ship and the diesel engine has been measured alone. Later these mobilities will be used to study the diesel engine as a vibration source.

Not only the mobilities but also the suitability of FE programs and the traditional calculation method was of interest in this study. In principle the mode superposition method should have worked well and with minimum manual work. However, at every step during the calculation starting from the modelling of the geometry the automatic functions failed due to the large size of the model causing much more manual work than expected. This makes it in practice impossible to use FE programs with the kind of limitations as I-Deas to calculate the mobilities up to required high frequencies.

On the other hand the high natural mode density at high frequencies of the large frequency range, makes the use of the traditional mode superposition method questionable. Another method to calculate the mobilities would be the direct calculation of responses at selected frequencies. This method is not available with I-Deas, but it can be estimated from the listed CPU times that in the CPU time, which was used to calculate the natural modes, about 100 direct solutions could have been calculated. That is mobilities 0 - 200 Hz with 2 Hz interval. The development of the vibration calculations has been concentrated on the natural mode extraction, but for the kind of calculations than in this study the direct solution method could become an feasible alternative.